

## T8600D, T8601D and T8602D Chronotherm® IV Deluxe Programmable Thermostats

### PRODUCT DATA



- Models available with outdoor temperature sensor capability for homeowner convenience. The sensor is also more accurate than a thermometer.
- Configurable features allows one model to be used to replace many different models (less inventory, no longer need to carry separate models to get these features).
  - °F or °C temperature display;
  - Automatic or manual changeover;
  - Electric or conventional heat fan operation
  - Adjustable heating cycle rate.
- Minimum off time for cooling compressors and heat pumps protects the equipment and extends the equipment life.
- Easy installation, setup and system test saves installer time and increases productivity.
- Self-test simplifies troubleshooting and saves time by overriding the time delays.
- Adaptive Intelligent Recovery™ control brings the room temperature to temperature setpoint at the programmed time, maximizing comfort and energy savings.
- Setpoints are permanently held in memory (no batteries used) and retained during power outages for increased installer and homeowner convenience.
- Power stealing, hardwired and battery powered models available for virtually all equipment and application needs.
- Universal Versaguard™ Thermostat guards available for added security.

### APPLICATION

The T8600, T8601 and T8602 Chronotherm® IV Deluxe Programmable Thermostats provide electronic control of 24 Vac single-stage heating and cooling systems.

### T8600/T8601/T8602 FEATURES AND BENEFITS

- Full seven-day program capability; different schedules and temperature setpoints may be selected for everyday to match the homeowner's flexible schedule.
- Copy key makes programming easier and faster for the installer and homeowner.
- Daylight Savings Time (DST) key for quick change in and out of Daylight Savings Time.
- Models available with programmable fan operation for added homeowner comfort.
- Easy temporary temperature setpoint changes for current period, vacation hold (1 to 255 days) or indefinite hold adds to the homeowner comfort and energy savings.
- Frequently used keys are located by the Liquid Crystal Display (LCD) for quick and easy access to information.
- Attractive styling complements any decor to the homeowner's delight.
- Back lighting the large display makes the LCD very easy to read.

### Contents

Application .....	1
T8600/T8601/T8602 Features and Benefits .....	1
Specifications .....	2
Ordering Information .....	2
Installation .....	4
Wiring .....	4
Settings .....	6
Installer Setup .....	7
Installer Self-Test .....	10
Thermostat Information .....	11
Programming .....	11
Operation .....	16
Troubleshooting Guide .....	17
Cross Reference .....	19
Wiring Diagrams (Fig. 15-20) .....	24



## SPECIFICATIONS

### IMPORTANT

*The specifications given in this publication do not include normal manufacturing tolerances. Therefore, this unit might not exactly match the listed specifications. This product is tested and calibrated under closely controlled conditions, and some minor differences in performance can be expected if those conditions are changed.*

### Thermostat Models

T8600, T8601 and T8602 Thermostats provide features listed in Table 1.

### Electrical Rating (Nominal Range):

24 Vac, 50/60 Hz.  
20 to 30 Vac, 50/60 Hz.

### Batteries:

Only T8602 models require batteries.

### Loss of Power:

The thermostat will maintain programmed times and temperatures for the life of the product. The clock and day information is retained for a minimum of thirty minutes.

### System Current Load Ratings:

6 VA maximum at 30 Vac, 50/60 Hz.

### Output Relay Load Rating:

See Table 2.

### Temperature:

Ratings:

Operating Ambient: 40°F to 110°F (4°C to 43°C).

Shipping: -30°F to +150°F (-34°C to +65°C).

Display Accuracy: ±1°F (±0.5°C).

### Setpoint:

Range:

Heating: 40°F to 90°F (4.5°C to 32°C).

Cooling: 45°F to 99°F (7°C to 35°C).

Differential: 3°F (1.5°C).

Default Settings: see Table 3.

### Minimum Stage Operation Time:

Minimum Off (Heat and Cool): factory setting 5 minutes; option 0 to 5 minutes.

### Humidity Ratings:

5% to 90% RH, noncondensing.

### Clock Accuracy:

±1 minute per month.

Table 1. Thermostat Features.

	System	Changeover	System Selection	Fan Selection	Comments
<b>T8600 (powered by either the heating or cooling system)</b>					
D	Heat-Cool	Automatic	Heat-Off-Cool-Auto	On-Auto	System and fan selections are done by keyboard.
<b>T8601 (powered by common wire to supply power)</b>					
D	Heat-Cool	Automatic	Heat-Off-Cool-Auto	On-Auto	System and fan selections are done by keyboard.
<b>T8602 (powered by batteries)</b>					
D	Heat-Cool	Automatic	Heat-Off-Cool-Auto	On-Auto	System and fan selections are done by keyboard.

## ORDERING INFORMATION

When purchasing replacement and modernization products from your TRADELINE® wholesaler or distributor, refer to the TRADELINE® Catalog or price sheets for complete ordering number.

If you have additional questions, need further information, or would like to comment on our products or services, please write or phone:

1. Your local Home and Building Control Sales Office (check white pages of your phone directory).
2. Home and Building Control Customer Logistics  
Honeywell Inc., 1885 Douglas Drive North  
Minneapolis, Minnesota 55422-4386

In Canada—Honeywell Limited/Honeywell Limitée, 35 Dynamic Drive, Scarborough, Ontario M1V 4Z9.

International Sales and Service Offices in all principal cities of the world. Manufacturing in Australia, Canada, Finland, France, Germany, Japan, Mexico, Netherlands, Spain, Taiwan, United Kingdom, U.S.A.

**Table 2. Maximum Amps at 30 Vac.**

Relay	Running (A)	Inrush (A)
Fan	0.5	2.5
Heat	1.5	3.5
Cool	1.5	7.5

**Table 3. Default Setpoints.**

Period	Time	Heat Setpoint	Cool Setpoint	Fan Setting
Wake	6:00 AM	70°F (21°C)	78°F (25.5°C)	Auto
Leave	8:00 AM	62°F (16.5°C)	85°F (29.5°C)	Auto
Return	6:00 PM	70°F (21°C)	78°F (25.5°C)	Auto
Sleep	10:00 PM	62°F (16.5°C)	82°F (28°C)	Auto

**Finish:**  
Taupe color.

**Dimensions:**  
See Fig. 1.

**Mounting Means:**  
The thermostat mounts on a wallplate. The wallplate mounts horizontally on a wall or outlet box with two no. 6 x 32 screws (included).

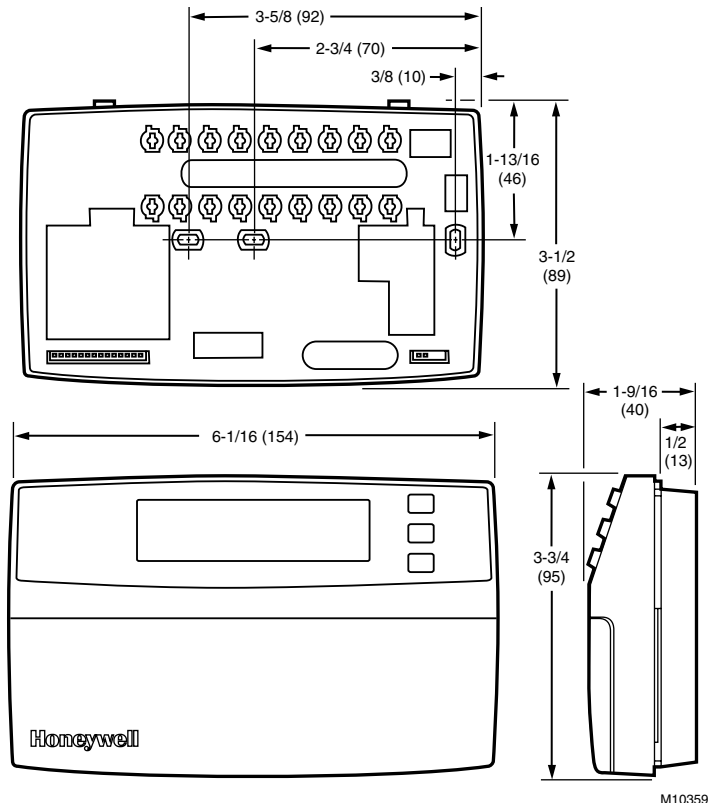
**Accessories:**  
C7089B Outdoor Temperature Sensors (69-1020).  
Universal Versaguard™ Thermostat guards.



**RECYCLING NOTICE**

If this control is replacing a control that contains mercury in a sealed tube, do not place your old control in the trash.

Contact your local waste management authority for instructions regarding recycling and the proper disposal of the old thermostat.



**Fig. 1. Dimensions of thermostat in in. (mm).**

M10359

## INSTALLATION

### When Installing this Product...

1. Read these instructions carefully. Failure to follow the instructions can damage the product or cause a hazardous condition.
2. Check the ratings given in the instructions and on the product to make sure the product is suitable for your application.
3. Installer must be a trained, experienced service technician.
4. After completing installation, use these instructions to check out the product operation.

### Location

Install the thermostat about 5 ft (1.5m) above the floor in an area with good air circulation at average temperature. See Fig. 2.

Do not install the thermostat where it can be affected by:

- drafts, or dead spots behind doors and in corners.
- hot or cold air from ducts.
- radiant heat from sun or appliances.
- concealed pipes and chimneys.
- unheated (uncooled) areas such as an outside wall behind the thermostat.

### Wallplate Installation

The thermostat can be mounted horizontally on the wall or on a 2 in. x 4 in. wiring box. Position wallplate horizontally on the wall or on a 2 in. x 4 in. wiring box.

1. Position and level the wallplate (for appearance only). The thermostat will function properly even when not level.
2. Use a pencil to mark the mounting holes. See Fig. 3.
3. Remove the wallplate from the wall and drill two 3/16 inch holes in the wall (if drywall) as marked. For firmer material such as plaster, drill two 7/32 inch holes. Gently tap anchors (provided) into the drilled holes until flush with the wall.
4. Position the wallplate over the holes, pulling wires through the wiring opening.
5. Loosely insert the mounting screws into the holes.
6. Tighten mounting screws.

## WIRING

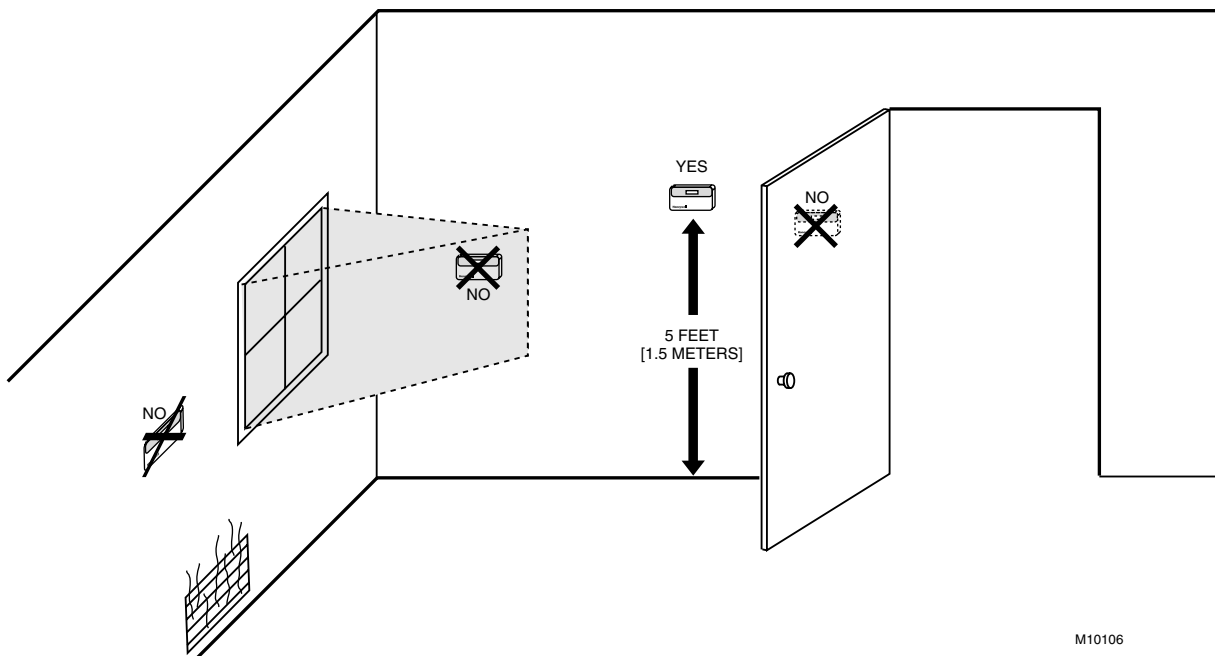
All wiring must comply with local electrical codes and ordinances. Follow equipment manufacturer wiring instructions when available. Refer to Fig. 15 through 20 for typical hookups. A letter code is located near each terminal for identification. Refer to Table 4 for terminal designations.



### CAUTION

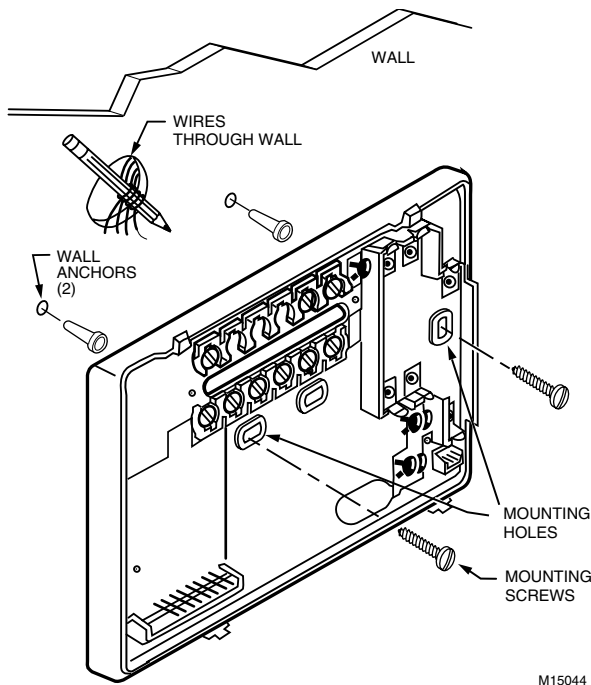
Disconnect power before wiring to prevent electrical shock or equipment damage.

1. Loosen the terminal screws on the wallplate and connect the system wires. See Fig. 4



M10106

Fig. 2. Typical location of thermostat.

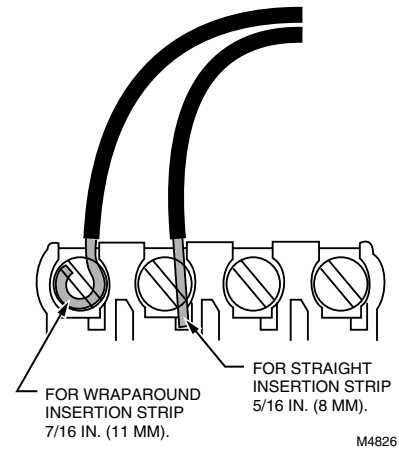


**Fig. 3. Mounting the wallplate.**

**IMPORTANT**

Use 18 gauge, color-coded thermostat cable for proper wiring.

2. Securely tighten each terminal screw.
3. Push excess wire back into the hole.
4. Plug the hole with nonflammable insulation to prevent drafts from affecting the thermostat.



**Fig. 4. Proper wiring technique.**

**Mounting Thermostat Wallplate**

The thermostat mounts on the wallplate after they are installed.

1. Engage tabs at the top of thermostat and wallplate. See Fig. 5.
2. Press lower edge of case to latch.

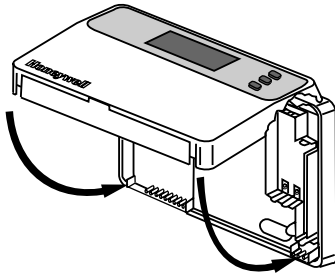
NOTE: To remove the thermostat from the wall, first pull out at the bottom of the thermostat; then remove the top.

**Table 4. Terminal Designations and Descriptions.**

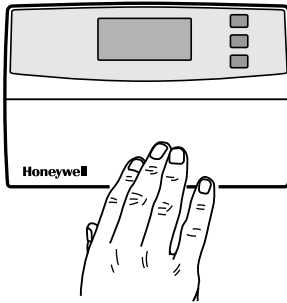
Standard Terminal Designations	Alternate Terminal Designations	Typical Connection	Function	Terminal Type
B	—	Heating damper or changeover valve	Output	24V powered contact
C	B <sup>a</sup> , C, X1, X2	Common	Input	
G	F	Fan relay	Output	24V powered contact
O	R	Cooling damper or changeover valve	Output	24V powered contact
OT, OT	—	Outdoor temperature sensor (C7089B)	Input	—
R	V	24V system or heating transformer	Input	—
RC	—	24V cooling transformer	Input	—
W	H1, R3	Heating relay	Output	24V powered contact
Y	C1, M	Compressor contactor	Output	24V powered contact

<sup>a</sup> Some OEM models label the terminal for transformer common B.

A. ENGAGE TABS AT TOP OF THERMOSTAT AND WALLPLATE.



B. PRESS LOWER EDGE OF CASE TO LATCH.



M15043

Fig. 5. Mounting thermostat on wallplate.

## SETTINGS

### Using Thermostat Keys

The thermostat keys are used to:

- set current day and time,
- program times and setpoints for heating and cooling,
- temporarily override program temperatures,
- display present setting,
- configure Installer Setup,
- check System Test,
- display outdoor temperature (select models),
- set the system operation,
- set the fan operation.

See Fig. 6 for the location of the keys.

### System and Fan Settings

The system default setting is Heat and the fan default setting is Auto. Use the System and Fan keys to change the settings. See Fig. 7. The fan settings can be set for each program period individually. The system selection is for all the program periods.

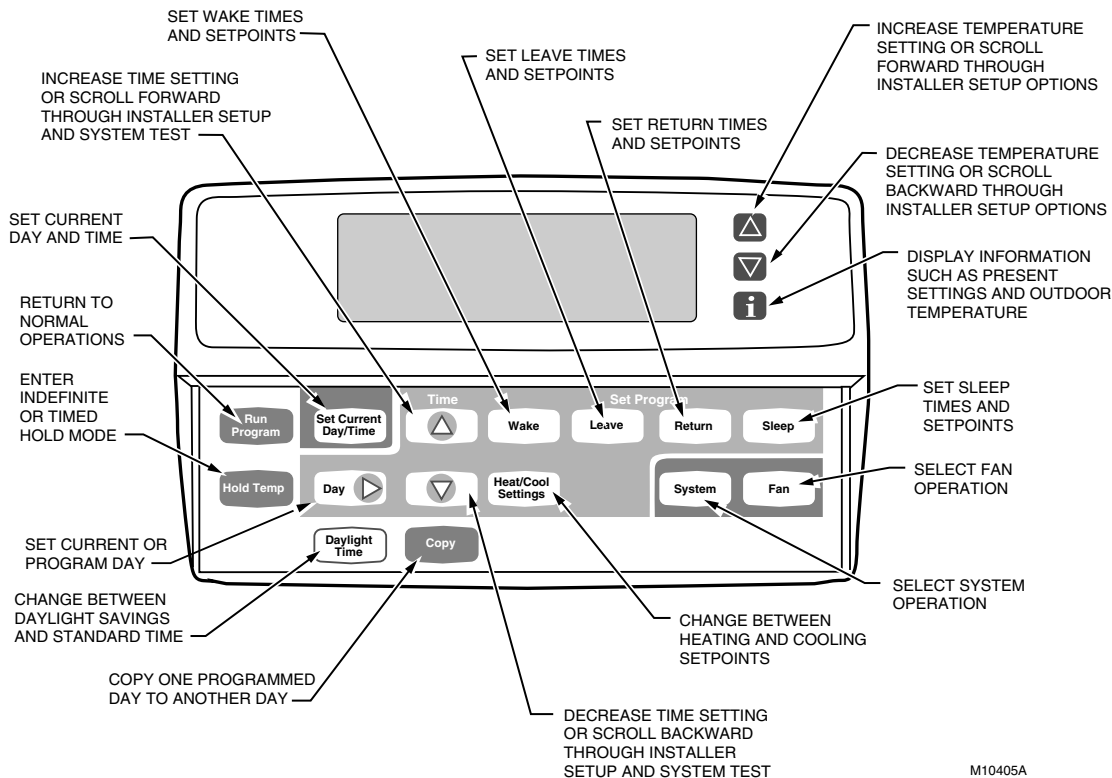


Fig. 6. Key locations and descriptions.

System settings control the thermostat operation as follows:  
 Heat: The thermostat controls the heating.  
 Off: Both the heating and cooling are off.  
 Cool: The thermostat controls the cooling.  
 Auto: The thermostat automatically changes between heating and cooling operation, depending on the indoor temperature.

Fan settings control the system fan as follows:  
 On: Fan operates continuously.  
 Auto: Fan operates with equipment.

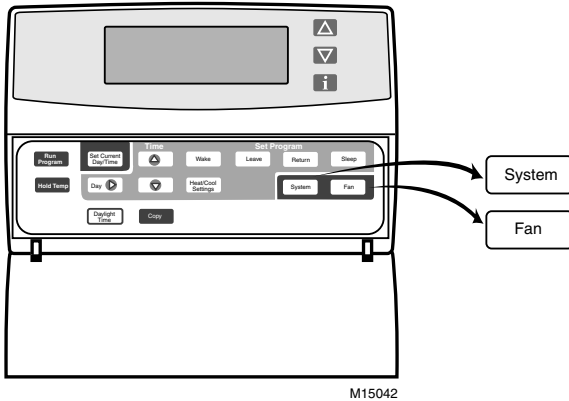


Fig. 7. Thermostat System and Fan key locations.

NOTE: Always press the keys with your fingertip or similar blunt tool. Sharp instruments like a pen or pencil point can damage the keyboard.

### Temperature Settings

Refer to Table 5 for the default program. If the daytime energy savings period is not used, press the period key (Leave or Return) until the time is blank. The fan setting feature is available on select thermostat models. See Programming Section for complete instructions on changing the program.

Table 5. Default Program Settings.

Period	Time	Heat Setpoint	Cool Setpoint	Fan Setting
Wake	6:00 AM	70°F (21°C)	78°F (25.5°C)	Auto
Leave	8:00 AM	62°F (16.5°C)	85°F (29.5°C)	Auto
Return	6:00 PM	70°F (21°C)	78°F (25.5°C)	Auto
Sleep	10:00 PM	62°F (16.5°C)	82°F (28°C)	Auto

## INSTALLER SETUP

NOTE: For most applications, the thermostat factory-settings will not need to be changed. Review the factory settings in Table 6 and if no changes are necessary, go to the Installer System Test section.

The Installer Setup is used to customize the thermostat to specific systems. Some of the options include temperature display, changeover and outdoor temperature display. Installer Setup numbers are listed in Table 6. The table includes all the configuration options and the factory-settings for the thermostat.

A combination of key presses are required to use the Installer Setup feature.

- To enter the Installer Setup, press and hold the Information **i** key with the increase **▲** and decrease **▼** keys until the first number is displayed. All display segments appear for approximately three seconds before the number is displayed. See Fig. 8 and 9.
- To advance to the next Installer Setup, press the Time **△** key.
- To change a setting, use the increase **▲** or decrease **▼** key.
- To scroll the Installer Setup numbers backwards, press the Time **▽** key.
- To exit the Installer Setup, press Run Program.

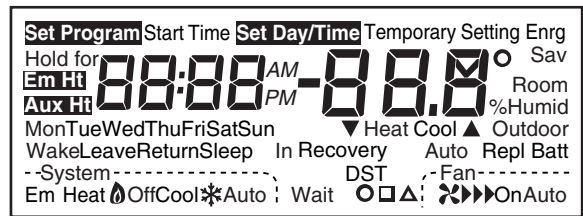


Fig. 8. Display of all the segments of the LCD.

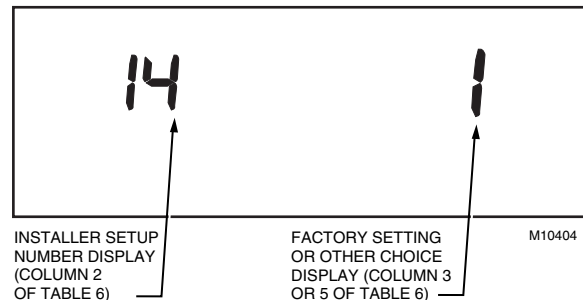


Fig. 9. Display of Installer Setup number and setting.

## CAUTION

Heat pump and electric heat systems must be configured to 1 in Installer Setup number 2 to prevent equipment damage caused by the system running without the fan.

### IMPORTANT

Only configurable numbers are shown on the device. Example: If thermostat does not have a system key, Installer Setup Number 12 will not be displayed. Review Table 6 factory-settings and mark any desired changes in the Actual Settings column. When Installer Setup is complete, review the settings to confirm that they match the system.

**Table 6. Thermostat Installer Setup Options.**

Select	Installer Setup Number (Press Time $\Delta$ key to change)	Factory-Setting		Other Choices (Press $\blacktriangle$ or $\blacktriangledown$ key to change)		Actual Setting
		Display	Description	Display	Description	
Not used	1	—	—	—	—	—
Fan operation <sup>a</sup>	2	0	Conventional applications where equipment controls fan operation in heat mode	1	Heat pump or electric heat applications where thermostat controls fan operation in heat mode	
Not used	3	—	—	—	—	—
Heating cycle rate	4	6	6—6 cph used for conventional heat	1, 3 or 9	1—1 cph used for radiant floor heat, gravity system 3—3 cph used for hot water systems or high efficiency furnaces 9—9 cph used for electric heat systems	
Not used	5 thru 11	—	—	—	—	—
System setting adjustment	12	1	Manual changeover	0 or 2	0—Auto changeover 2—Fixed auto changeover	
Adaptive Intelligent Recovery™ control	13	0	Adaptive Intelligent Recovery™ control is activated (system starts early so setpoint is reached by start of program period)	1	Conventional recovery (system starts recovery at programmed time)	—
Degree temperature display	14	0	Temperature is displayed in °F	1	Temperature is displayed in °C	
Not used	15	—	—	—	—	—
Clock format	16	0	12-hour clock format	1	24-hour clock format	
Not used	17 and 18	—	—	—	—	—
Extended fan operation in heating <sup>a</sup>	19	0	No extended fan operation after the call for heat ends	1	Fan operation is extended 90 seconds after the call for heat ends.	
Extended fan operation in cooling	20	0	No extended fan operation after the call for cool ends	1	Fan operation is extended 90 seconds after the call for cool ends.	
Not used	21 thru 23	—	—	—	—	—
Outdoor temperature display (select models)	24	0	No outdoor temperature is displayed	1	Outdoor temperature is displayed. Needs a C7089B1000 Outdoor Sensor to operate	
Not used	25 thru 29	—	—	—	—	—
Deadband	30	3	Heating and cooling setpoints can be set no closer than 3°F (1.5°C)	4 thru 10	Heating and cooling setpoints can be set no closer than the chosen value: 4—4°F (2°C) 5—5°F (2.5°C) 6—6°F (3°C) 7—7°F (3.5°C) 8—8°F (4°C) 9—9°F (4.5°C) 10—10°F (5°C)	

<sup>a</sup> Number 2 must be set to 1 to extend fan operation.

(continued)



**Table 6. Thermostat Installer Setup Options (continued).**

Select	Installer Setup Number (Press Time $\Delta$ key to change)	Factory-Setting		Other Choices (Press $\blacktriangle$ or $\blacktriangledown$ key to change)		Actual Setting
		Display	Description	Display	Description	
Not used	31 and 32	—	—	—	—	—
Minimum off time for the compressor	33	5	5 minute minimum off time for the compressor	0 thru 4	Minimum number of minutes (0 thru 5) the compressor will be off between calls for the compressor	
Temperature range stops in heating	34	90	Highest setpoint heating can be set to	40 to 89	Temperature range (1°F increments) heating setpoint can be set to	
Temperature range stops in cooling	35	45	Lowest setpoint cooling can be set to	46 to 99	Temperature range (1°F increments) cooling setpoint can be set to	
Not used	36	—	—	—	—	—
Temperature display adjustment	37	0	No difference in displayed temperature and actual room temperature	3 thru -3	1—Display adjusts to 1°F higher than actual room temperature 2—Display adjusts to 2°F higher than actual room temperature 3—Display adjusts to 3°F higher than actual room temperature -1—Display adjusts to 1°F lower than actual room temperature -2—Display adjusts to 2°F lower than actual room temperature -3—Display adjusts to 3°F lower than actual room temperature	

<sup>a</sup> Number 2 must be set to 1 to extend fan operation.

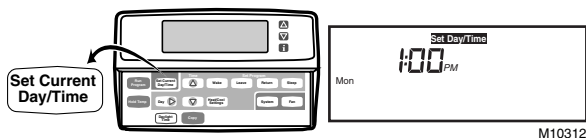
**IMPORTANT**

Review the settings to confirm that they match the system. Press Run Program to exit the Installer Setup. The thermostat has saved the Installer Setup changes and initiated a reset in order to operate with these new settings. Be sure to set the current day and time immediately.

**Setting Current Day and Time**

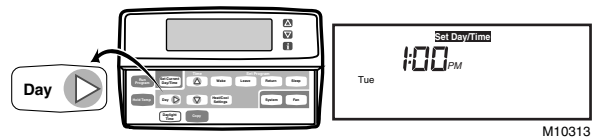
1. Press Set Current Day/Time.

NOTE: On initial power up or after an extended power loss, 1:00 pm flashes on the display until a key is pressed.



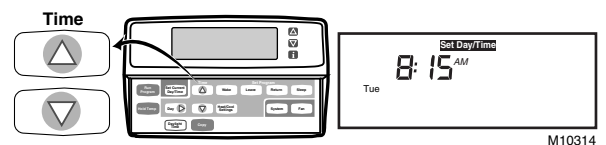
2. Press Day until the current day is displayed.

NOTE: Sun=Sunday, Mon=Monday, Tue=Tuesday, Wed=Wednesday, Thu=Thursday, Fri=Friday, Sat=Saturday.

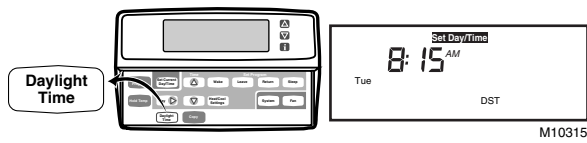


3. Press Time  $\Delta$  or Time  $\blacktriangledown$  until the current time is displayed.

NOTE: Tapping the Set Current Day/Time will change the time in one hour increments.



NOTE: If the current time is Daylight Savings Time, press Daylight Time until DST is displayed.



4. Press Run Program.

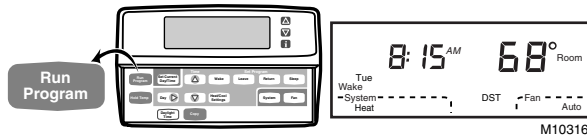


Fig. 10. Display of all the segments of the LCD.



Fig. 11. Display of test number.

## INSTALLER SYSTEM TEST

Use the Installer System Test to check the thermostat operation. Refer to Table 7 for a list of the available system tests.

To start the system test:

### CAUTION

The minimum off time for compressors is bypassed during the Installer System Test. Equipment damage can occur if the compressor is cycled too quickly.

Press and hold the increase ▲ and ▼ decrease keys, at the same time, until 10 appears. All segments of the display are displayed for three seconds before 10 appears. See Fig. 10 and 11.

Table 7. Tests Available in Installer System Test.

Test Number	System Test Description
10-19	Heating equipment can be turned on and off
30-39	Cooling equipment can be turned on and off
40-49	Fan equipment can be turned on and off
60 0 to 60 19	Keyboard keys test
70-79	Thermostat information including date code and software versions are displayed

Refer to Table 8 for the directions and results of the specific tests.

NOTE: Press Time △ to advance to the next test and Time ▼ to go to the previous test. Press Run Program to exit the system test.

Table 8. Installer System Test Options.

Key to Press	Test Number	Description
<b>Heating Equipment System Test</b>		
Time △	10	Enter heating equipment system test.
▲	11	Heat comes on. When Installer Setup number 2 is 1, the system fan is also energized.
▼	10	Heat and system fan turn off.
<b>Cooling Equipment System Test</b>		
Time △	30	Change from heating to cooling equipment system test.
▲	31	Cool and system fan come on.
▼	30	Cool and system fan turn off.
<b>Fan Equipment System Test</b>		
Time △	40	Change from cooling to fan equipment system test.
▲	41	Fan comes on.
▼	40	Fan turns off.
<b>Key Operation System Test</b>		
Time △	60 2	Change from fan to key operation system test.

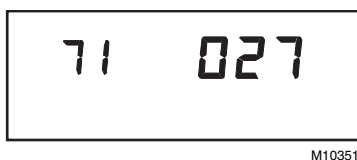
NOTE: Press any key and the numbers will change on the display. Press Time ▾ to scroll backwards and Time △ to scroll forward. The Run Program, Key will not exit from this test. To exit, go to a different test and press Run Program.

## THERMOSTAT INFORMATION

1. Press the Time △ key to access the thermostat information.



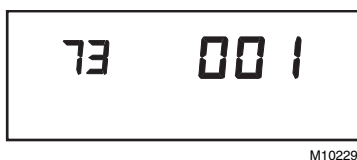
2. Press the increase ▲ key to display the production date code. The first two large digits are the month and the third digit is the last digit of the year (Example: 027=February 1997).



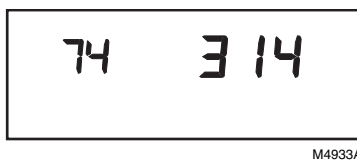
3. Press the increase ▲ key again to display the software identification code. (Example: 02 = software ID code 2)



4. Press the increase ▲ key again to display the software revision number (Example: 001=Revision number 1).



5. Press the increase ▲ key again to display the EEPROM identification code. (Example: 314 = EEPROM ID 314)
6. Press the Run Program key to exit the system test. The



system test times out after five minutes without any key presses.

## PROGRAMMING

The keyboard is located behind the thermostat cover with three frequently used keys by the display. The thermostat display shows day, time, program period, temperature, system and fan operation selection.

The thermostat can be set for four times and up to eight temperatures for each day of the week (28 independent time and 56 temperature settings). The △ and ▾ keys provide quick temporary temperature changes to increase comfort. The Hold Temp key provides energy efficient operation for extended periods of time.

Before starting the programming procedure, use Table 9 to organize the program schedule. The factory preprogrammed time, temperature and fan settings are shown in brackets. If a daytime energy savings period is not used, press the period key (Leave or Return) until the time is blank. The fan setting feature is available on select thermostat models.

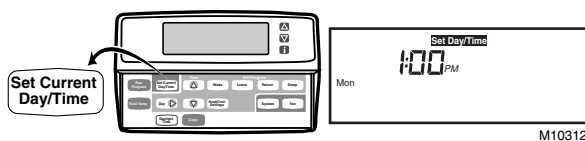
### Setting the Current Day and Time

#### IMPORTANT

Always press the keys with your fingertip or similar blunt tool. Sharp instruments like pens and pencil points can damage the keyboard.

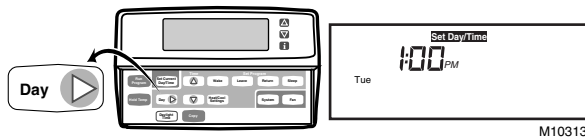
1. Press Set Current Day/Time.

NOTE: On initial power up or after an extended power loss, 1:00 pm flashes on the display until a key is pressed.



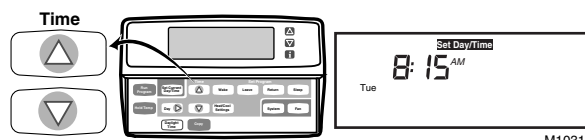
2. Press Day until the current day is displayed.

NOTE: Sun = Sunday, Mon = Monday, Tue = Tuesday, Wed = Wednesday, Thu = Thursday, Fri = Friday, Sat = Saturday.

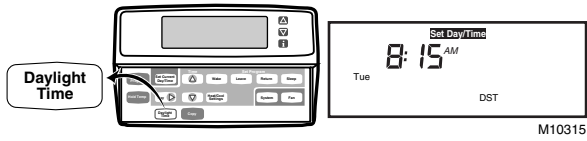


3. Press Time △ or Time ▾ until the current time is displayed.

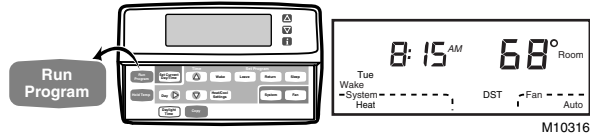
NOTE: Tapping the Set Current Day/Time will change the time in one hour increments.



NOTE: If the current time is Daylight Savings Time, press Daylight Time until DST is displayed.



4. Press Run Program.



### Programming the First Day

Start by programming the Wake time and temperature (and fan operation on select models) for any one day:

1. Press Wake.

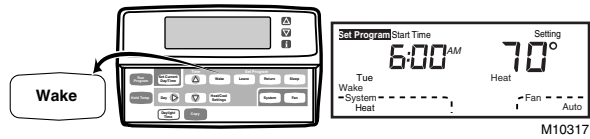


Table 9. Default Time, Setpoints and Fan Settings.

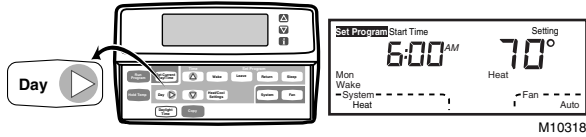
Period	Start Time	Heat Setpoint	Cool Setpoint	Fan Setting
<b>Monday</b>				
Wake	[6:00 AM]	[70°F (21°C)]	[78°F (25.5°C)]	[Auto]
Leave	[8:00 AM]	[62°F (16.5°C)]	[85°F (29.5°C)]	[Auto]
Return	[6:00 PM]	[70°F (21°C)]	[78°F (25.5°C)]	[Auto]
Sleep	[10:00 PM]	[62°F (16.5°C)]	[82°F (28°C)]	[Auto]
<b>Tuesday</b>				
Wake	[6:00 AM]	[70°F (21°C)]	[78°F (25.5°C)]	[Auto]
Leave	[8:00 AM]	[62°F (16.5°C)]	[85°F (29.5°C)]	[Auto]
Return	[6:00 PM]	[70°F (21°C)]	[78°F (25.5°C)]	[Auto]
Sleep	[10:00 PM]	[62°F (16.5°C)]	[82°F (28°C)]	[Auto]
<b>Wednesday</b>				
Wake	[6:00 AM]	[70°F (21°C)]	[78°F (25.5°C)]	[Auto]
Leave	[8:00 AM]	[62°F (16.5°C)]	[85°F (29.5°C)]	[Auto]
Return	[6:00 PM]	[70°F (21°C)]	[78°F (25.5°C)]	[Auto]
Sleep	[10:00 PM]	[62°F (16.5°C)]	[82°F (28°C)]	[Auto]
<b>Thursday</b>				
Wake	[6:00 AM]	[70°F (21°C)]	[78°F (25.5°C)]	[Auto]
Leave	[8:00 AM]	[62°F (16.5°C)]	[85°F (29.5°C)]	[Auto]
Return	[6:00 PM]	[70°F (21°C)]	[78°F (25.5°C)]	[Auto]
Sleep	[10:00 PM]	[62°F (16.5°C)]	[82°F (28°C)]	[Auto]
<b>Friday</b>				
Wake	[6:00 AM]	[70°F (21°C)]	[78°F (25.5°C)]	[Auto]
Leave	[8:00 AM]	[62°F (16.5°C)]	[85°F (29.5°C)]	[Auto]
Return	[6:00 PM]	[70°F (21°C)]	[78°F (25.5°C)]	[Auto]
Sleep	[10:00 PM]	[62°F (16.5°C)]	[82°F (28°C)]	[Auto]
<b>Saturday</b>				
Wake	[6:00 AM]	[70°F (21°C)]	[78°F (25.5°C)]	[Auto]
Leave	[8:00 AM]	[62°F (16.5°C)]	[85°F (29.5°C)]	[Auto]
Return	[6:00 PM]	[70°F (21°C)]	[78°F (25.5°C)]	[Auto]
Sleep	[10:00 PM]	[62°F (16.5°C)]	[82°F (28°C)]	[Auto]

(continued)

Table 9. Default Time, Setpoints and Fan Settings (continued).

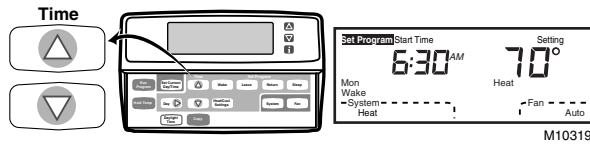
Period	Start Time	Heat Setpoint	Cool Setpoint	Fan Setting
<b>Sunday</b>				
Wake	[6:00 AM]	[70°F (21°C)]	[78°F (25.5°C)]	[Auto]
Leave	[8:00 AM]	[62°F (16.5°C)]	[85°F (29.5°C)]	[Auto]
Return	[6:00 PM]	[70°F (21°C)]	[78°F (25.5°C)]	[Auto]
Sleep	[10:00 PM]	[62°F (16.5°C)]	[82°F (28°C)]	[Auto]

2. Press Day until the desired day is displayed.



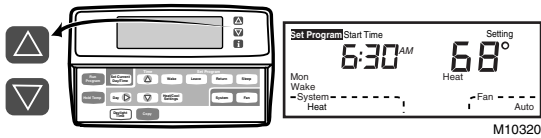
3. Press Time  $\Delta$  or Time  $\nabla$  until the desired Wake time is displayed.

NOTE: The program times are in fifteen minute intervals. (Example: 8:00, 8:15, 8:30).



4. Press increase  $\Delta$  or decrease  $\nabla$  key until the desired Wake temperature is displayed.

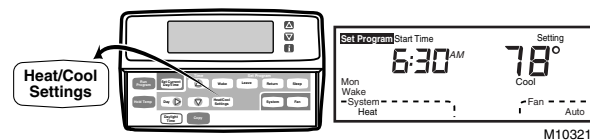
NOTE: The setpoint temperature range is 40 to 90°F (7 to 31°C) for heating and 45 to 99°F (9 to 37°C) for cooling.



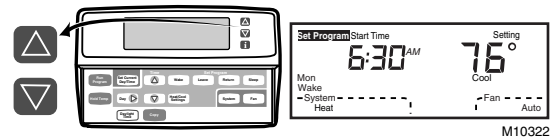
NOTE: Press Fan to modify fan operation. Auto means the fan will run only when the heating or cooling equipment is operating. On means the fan will run continuously for the entire period.

5. Press Heat/Cool Settings to switch to other system temperature setpoint.

NOTE: The program times are the same for both heating and cooling.



6. Press increase  $\Delta$  or decrease  $\nabla$  key until the desired temperature setpoint is displayed.

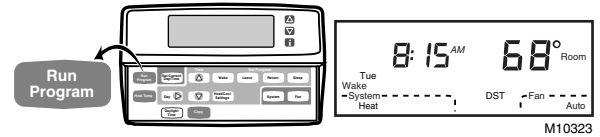


7. Press Leave, Return or Sleep and repeat steps 3, 4, 5 and 5 for programming the rest of the day. The first day is now programmed.

**IMPORTANT**

Repeat steps 1 through 7 for each day of the week that has a different program than the first day. Refer to Copying a Day section to copy any program day to another.

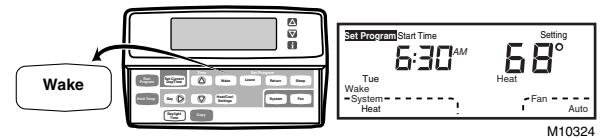
8. Press Run Program when all days are programmed.



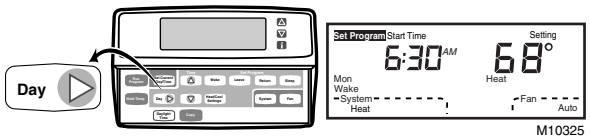
**Copying a Day**

NOTE: The thermostat must be in the program mode to use the copy feature. Go to step 2 if the thermostat is already in the program mode.

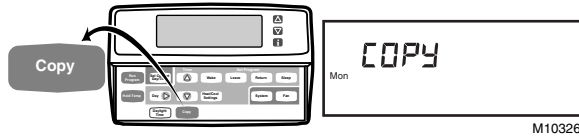
1. Press Wake.



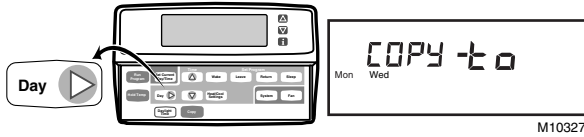
2. Press Day to select the day to be copied if different from the day displayed.



- Press Copy.

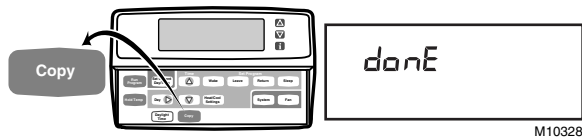


- Press Day until the day to be copied to is displayed.



- Press Copy.

NOTE: donE will be displayed for two seconds and then the normal program display will be shown.



- Repeat steps 2 through 5 for all the days desired.
- Press Run Program.

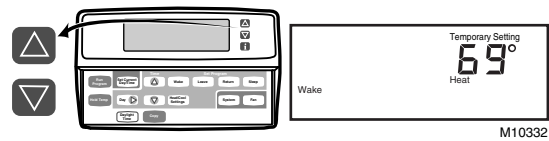
- Repeat steps 2 and 3 for all the periods to be cleared.
- Press Run Program.

## Setting Temporary Temperatures

### Changing Temperature Setting Until the Next Program Period

Press increase ▲ or decrease ▼ key until the desired temperature setpoint is displayed.

NOTE: If ▼ or ▲ appear under the temperature display, it means that both the heating and cooling setpoints are being adjusted. Tapping the key will change both the heat and cool setpoints by one degree. Press i after the desired setpoint is reached to check the setpoints.

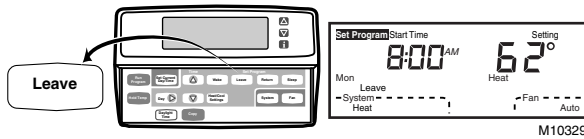


NOTE: The temporary temperature setting is displayed for approximately 3 seconds. The setting is canceled when the next period starts or when Run Program is pressed.

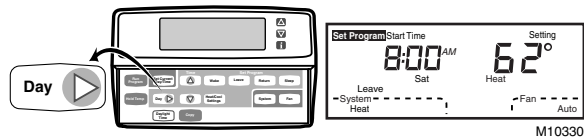
## Clearing Program Period

NOTE: The thermostat must be in the program mode to use the clear feature. Go to step 2 if the thermostat is already in the program mode.

- Press Wake, Leave, Return or Sleep.

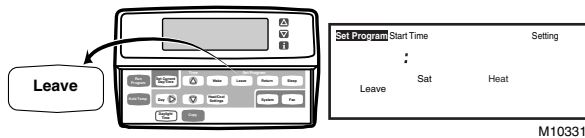


- Press Day until the desired day is displayed.



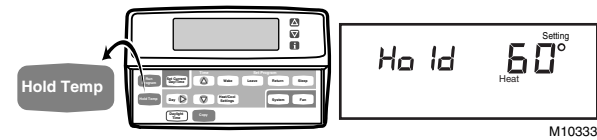
- Press Leave, Return or Sleep until the start time and temperature setting are cleared (approximately 3 seconds).

NOTE: Wake cannot be cleared.

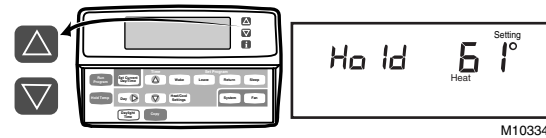


## Changing Temperature Setting Indefinitely

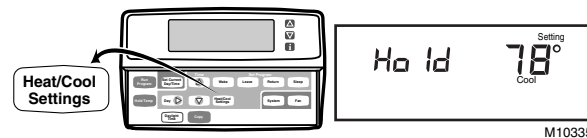
- Press Hold Temp.



- Press increase ▲ or decrease ▼ key to change the setting, if desired.



- Press Heat/Cool Settings to change between heat and cool settings.



- Press increase ▲ or decrease ▼ key to adjust temperature settings.

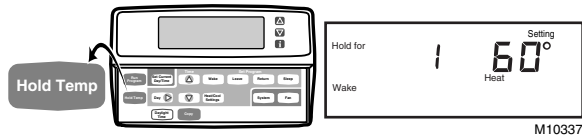


NOTE: The display changes from the setpoint to the room temperature after approximately 3 seconds.

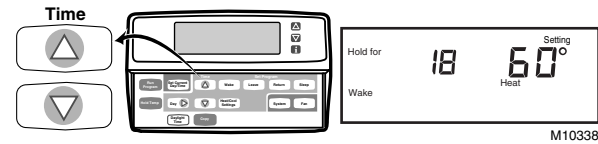
5. Press Run Program to cancel the Hold and to return to the program.

## Changing Temperature Setting Until a Designated Day and Period

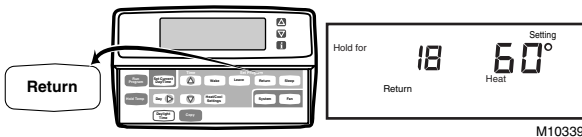
1. Press Hold Temp twice.



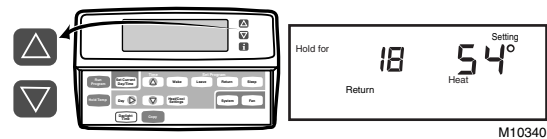
2. Press Time  $\Delta$  or Time  $\nabla$  until the desired number of days is displayed (1 to 255 days). (Example: 18 = Hold will override the daily programs for 18 days)



3. Press Wake, Leave, Return or Sleep to select the period the program will start. (Example: Return = thermostat will stop the Hold at the Return period start time)



4. Press increase  $\blacktriangle$  or decrease  $\blacktriangledown$  key to adjust the temperature setting, if desired. (Example: Heat 54° = heating equipment will operate when the room temperature is below 54°F)



NOTE: When the System is set for Auto (select models), both heat and cool settings are needed. If the System is set for Heat, only the Heat setpoint is needed or if Cool is selected, only the Cool setpoint is needed.

5. Press Heat/Cool Settings to change between heat and cool settings.
6. Press increase  $\blacktriangle$  or decrease  $\blacktriangledown$  key to adjust the temperature setting, if desired. (Example: Cool 84° = cooling equipment will operate when the room temperature is above 84°F)

NOTE: In this example, the thermostat uses the Hold setting for eighteen days and returns to the daily programs at the Return period start time. The temperature settings are heating 54°F and cooling 84°F. Only the heating temperature is used because the System is set for Heat. The thermostat will use both the heating and cooling temperature settings when the System is set to Auto (select models).

### IMPORTANT

*If the Hold needs to be canceled before the designated time, press Run Program to return to the program.*

## Setting System and Fan

The system default setting is Heat and the fan default setting is Auto. Use the System and Fan keys to change the settings. See Fig. 12. The fan settings can be set for each program period individually. The system selection is for all the program periods.

System settings control the thermostat operation as follows:  
 Heat: The thermostat controls the heating.  
 Off: Both the heating and cooling are off.  
 Cool: The thermostat controls the cooling.  
 Auto: The thermostat automatically changes between heating and cooling operation, depending on the indoor temperature.

Fan settings control the system fan as follows:  
 On: Fan operates continuously.  
 Auto: Fan operates with equipment.

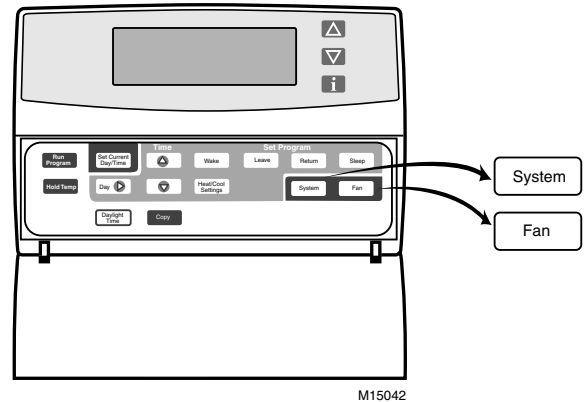


Fig. 12. Thermostat System and Fan key locations.

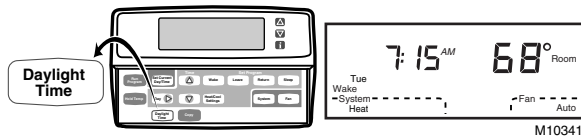
## Setting Temporary Fan Operation

If your thermostat has a Fan key and this feature, press Fan until the desired fan operation is selected. This fan setting will be in effect until the next regularly scheduled period starts.

## Using Daylight Savings Time Feature

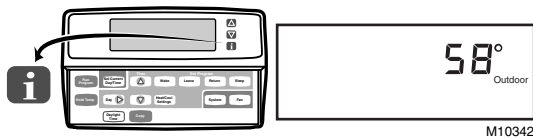
This feature allows you to change in and out of Daylight Savings Time with a key press. When the Daylight Time Key is pressed in the fall, the time will go back one hour. In the spring, the time will go ahead one hour and the display will show DST. See Setting the Current Day and Time section for initial setting instructions.

**NOTE:** Pressing the Daylight Time Key more than once within a five minute period will scroll you through various time options (Example: one hour earlier or later with or without DST). Pressing the Daylight Time Key six times in a five minute period will return you to your original settings.



## Displaying the Outdoor Temperature

If your thermostat is equipped with an outdoor sensor, you can check the temperature at the sensor by pressing **i** once.



## OPERATION

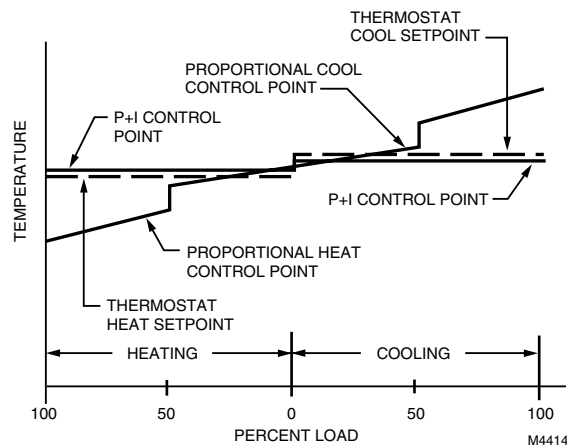
### P+I Control

The thermostat microprocessor based control requires that the user understands temperature control and thermostat performance. A conventional electromechanical or electronic thermostat does not control temperature precisely at setpoint. Typically, there is an offset (droop) in the control point as the system load changes. This is a phenomenon that most people in the industry know and accept. Many factors contribute to offset including switch differential, thermal lag, overshoot, cycle rates and system load.

The thermostat microprocessor simultaneously gathers, compares and computes data. Using this data, it controls a wide variety of functions. The special proprietary algorithm (program) in the thermostat eliminates the factors causing offset. This makes temperature control more accurate than the conventional electromechanical or electronic thermostats. The temperature control algorithm is called proportional plus integral (P+I) control.

The thermostat sensor, located on the thermostat or remote, senses the current space temperature. The proportional error is calculated by comparing the sensed temperature to the programmed setpoint. The deviation from the setpoint is the proportional error.

The thermostat also determines integral error, which is a deviation based on the length of error time. The sum of the two errors is the (P+I) error. The cycle rate used to reach and maintain the setpoint temperature is computed using the P+I. The addition of the integral error is what differentiates the thermostat from many other electronic and electromechanical thermostats. See Fig. 13.



**Fig 13. Proportional temperature control versus P+I temperature control.**

## Operation Sequence

The thermostat energizes specific terminals depending what the Fan and System are set to. The LCD will display the time, room temperature, system and fan selection. Symbols will be displayed when the heating, cooling or fan is energized. See Table 10 for specific information.

**NOTE:** Not all the thermostat models have all the terminals listed in the Energize column.

**Table 10. Conventional System Sequence of Operation.**

Selection		Call	Energize	Display
Fan	System			
Auto	Off	None	None	None
On	Off	None	G	⊗
Auto	Cool	None	O	None
Auto	Cool or Auto	Cooling	O, G and Y	❄️ and ⊗
Auto	Heat	None	B	None
Auto	Heat or Auto	Heating	B and W <sup>a</sup>	🔥
Auto	Auto	None	O or B <sup>b</sup>	None

<sup>a</sup> When electric heat fan is selected, G is energized and fan symbol is displayed.

<sup>b</sup> Based on last piece of equipment called (cooling = O or heating = B) and Installer Setup selection.

## Equipment Protection

As part of the operational sequence, the thermostat microprocessor also incorporates minimum off time for all cooling stages. Using the minimum off time assures that rapid cycling of equipment does not occur, which extends equipment life. Minimum off times are set in the Installer Setup.



## Thermostat Operation

### Startup

When power to the thermostat is turned on, a startup and initialization program begins. The startup occurs only on initial powerup. After total loss of power for an extended period, the current time and day may need to be set, but the user program is held. See Table 11 for the default values.

NOTE: Immediately following initialization, the user can enter new setpoints to be used in place of the default values.

**Table 11. Default Time, Setpoint and Fan Settings.**

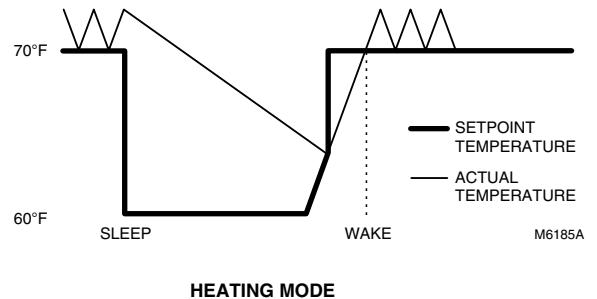
Period	Time	Heat Setpoint	Cool Setpoint	Fan Setting
Wake	6:00 AM	70°F (21°C)	78°F (25.5°C)	Auto
Leave	8:00 AM	62°F (16.5°C)	85°F (29.5°C)	Auto
Return	6:00 PM	70°F (21°C)	78°F (25.5°C)	Auto
Sleep	10:00 PM	62°F (16.5°C)	82°F (28°C)	Auto

### Adaptive Intelligent Recovery® Feature

Adaptive Intelligent Recovery® ensures that the comfort setting is achieved at the programmed time regardless of weather conditions. Conventional recovery, however, starts recovery at the beginning of the programmed time period and uses the equipment to achieve the comfort settings as soon as possible.

Adaptive Intelligent Recovery® calculates the recovery ramp based on the number of degrees away from the desired setpoint, previous equipment performance, and weather history to initiate recovery at the optimal time to achieve the comfort setting at the desired time.

Once the recovery ramp is intersected, the setpoint changes from the setback setpoint to the comfort setpoint. This change *snaps on* the equipment and runs the equipment until the setpoint is reached. If the setpoint is reached too early or too late, the ramp is adjusted for the next days' recovery.



**Fig. 14. Temperature change in recovery.**

## TROUBLESHOOTING GUIDE

Refer to Table 12 for troubleshooting information.

**Table 12. Troubleshooting Information.**

Symptom	Possible Cause	Action
Display will not come on.	Thermostat is not being powered.	<ul style="list-style-type: none"> <li>• Check for 24 Vac between R and C or W terminals.                             <ul style="list-style-type: none"> <li>— If missing 24 Vac:                                     <ul style="list-style-type: none"> <li>— check if the circuit breaker is tripped—reset the circuit breaker.</li> <li>— check if the system fuse is blown—replace the fuse.</li> <li>— check if the power switch on the HVAC equipment is in the Off position—set to the On position.</li> <li>— check wiring between thermostat and HVAC equipment—replace any broken wires and tighten any loose connections.</li> </ul> </li> <li>— If 24 Vac is present, proceed with troubleshooting.</li> </ul> </li> </ul>
Temperature display is incorrect.	Room temperature display has been reconfigured.	Enter Installer Setup number 37 and reconfigure the display.
	Thermostat is configured for °F or °C display.	Enter Installer Setup number 14 and reconfigure the display.
	Bad thermostat location.	Relocate the thermostat.
Temperature settings will not change. (Example: Cannot set the heating higher or the cooling lower.)	The upper or lower temperature limits were reached.	Check the temperature setpoints: <ul style="list-style-type: none"> <li>• Heating limits are 40 to 90°F (4.5 to 32°C)</li> <li>• Cooling limits are 45 to 99°F (7 to 35°C) except D model cooling limits are 48 to 99°F.</li> </ul>
	The setpoint temperature range stops were configured.	Check Installer Setup numbers 34 and 35 and reconfigure the setpoint stops.
Heating will not come on.	No power to the thermostat.	<ul style="list-style-type: none"> <li>• Setpoint is above room temperature.</li> <li>• Check for 24 Vac between R and C or W terminals.                             <ul style="list-style-type: none"> <li>— If missing 24 Vac:                                     <ul style="list-style-type: none"> <li>— check if the circuit breaker is tripped—reset the circuit breaker.</li> <li>— check if the system fuse is blown—replace the fuse.</li> <li>— check if the power switch on the HVAC equipment is in the Off position—set to the On position.</li> <li>— check wiring between thermostat and HVAC equipment—replace any broken wires and tighten any loose connections.</li> </ul> </li> <li>— If 24 Vac is present, proceed with troubleshooting.</li> </ul> </li> </ul>
Heating will not come on.	Thermostat minimum off time is activated.	Wait up to five minutes for the system to respond.
	System selection is not set to Heat.	Set system selection to Heat.
	Heating setpoint is below room temperature.	Check heating setpoint. Set heating setpoint to desired temperature.
Cooling will not come on.	No power to the thermostat.	<ul style="list-style-type: none"> <li>• Setpoint is below room temperature.</li> <li>• Check for 24 Vac between R or RC and C or Y terminals (D models requires power to R at all times).                             <ul style="list-style-type: none"> <li>— If missing 24 Vac:                                     <ul style="list-style-type: none"> <li>— check if the circuit breaker is tripped—reset the circuit breaker.</li> <li>— check if the system fuse is blown—replace the fuse.</li> <li>— check if the power switch on the HVAC equipment is in the Off position—set to the On position.</li> <li>— check wiring between thermostat and HVAC equipment—replace any broken wires and tighten any loose connections.</li> </ul> </li> <li>— If 24 Vac is present, proceed with troubleshooting.</li> </ul> </li> </ul>
	Thermostat minimum off time is activated.	<ul style="list-style-type: none"> <li>• Wait up to five minutes for the system to respond.</li> <li>• Enter Installer Setup number 33. Reconfigure minimum off time (if required).</li> </ul>
	System selection is not set to Cool.	Set system selection to Cool.
	Cool setpoint is above room temperature.	Check cooling setpoint. Set cooling setpoint to desired temperature.

(continued)

**Table 12. Troubleshooting Information (continued).**

Symptom	Possible Cause	Action
Heating or cooling come on momentarily and shut off	Heat or cool circuit is opening up or becoming high impedance.	Add resistor in parallel with load or install interface relay.
System on indicator (flame=heat, snowflake=cool) is displayed, but no warm or cool air is coming from the registers.	Fan operation set for 0 (conventional heat) when it should be set for 1 (electric heat).	Enter Installer Setup number 2 and reconfigure the fan operation.
	Conventional heating equipment turns on the fan when the furnace has warmed up to a setpoint.	Wait a minute after seeing the on indicator and then check the registers.
	Heating or cooling equipment is not operating.	Verify operation of heating or cooling equipment in self-test.
Outdoor temperature not displayed <sup>a</sup>	Option not activated.	Enter Installer Setup number 24 and set to 1. Thermostat must have OT terminals and a C7089B1000 installed.
Outdoor temperature display is incorrect <sup>a</sup>	Outdoor sensor is connected incorrectly.	Refer to C7089B1000 installation instructions and check wiring between the thermostat and sensor.
	Wrong sensor.	Replace sensor with C7089B1000 sensor.

<sup>a</sup> Available on select models.

## CROSS REFERENCE

All SUPER TRADELINE® Chronotherm® IV thermostats are different from the existing Chronotherm® III devices as summarized in Table 13.

Refer to Table 14 for thermostat cross referencing information.

**Table 13. Differences Between Chronotherm® III Thermostats and Chronotherm® IV Thermostats.**

Feature/Function	Chronotherm® III Family	Chronotherm® IV Family
Programming	5-1-1 day programming	7-day programming
Changeover	Automatic or manual changeover models available	Automatic/manual changeover selectable
Installer configuration	Field settings made via screws on the back of the thermostat	Field settings made through the keyboard
System switching	Mechanical switch	Keyboard entry
Fan switching	Mechanical switch	Keyboard entry
Device color	Beige or Premier White® color	Taupe or Premier White® color

**Table 14. Thermostat Cross Reference Information.**

Model Number	Description	TRADELINE® Replacement	Remarks
<b>T8600A</b>	<b>One-stage heat conventional thermostat; system powered; system switch—none; fan switch—none.</b>		
T8600A1000	Honeywell logo.	T8600D2028	Heat/cool model can be used for heat only; system selection Heat-Off-Cool-Auto; duel fuel.
T8600A1018	Canadian TRADELINE® thermostat; Honeywell logo; degree C.	T8600D2028	Heat/cool model can be used for heat only; system selection Heat-Off-Cool-Auto; configure for °C in Installer Setup 14; duel fuel.
T8600A1034	Canadian TRADELINE® thermostat; Honeywell logo; Premier White® color; degree C.	T8600D2028	Heat/cool model can be used for heat only; system selection Heat-Off-Cool-Auto; configure for °C in Installer Setup 14; duel fuel.
<b>T8600B</b>	<b>One-stage heat and one-stage cool conventional thermostat; system powered</b>		
T8600B1008	TRADELINE® thermostat; Honeywell logo; system switch—HEAT-OFF; fan switch—none.	T8600D2028	Heat/cool model can be used for heat only; system selection Heat-Off-Cool-Auto; fan selection On-Auto; duel fuel; no positive off.
T8600B1016	TRADELINE® thermostat; Honeywell logo; system switch—none; fan switch—ON-AUTO.	T8600D2028	Heat/cool model can be used for heat only; system selection Heat-Off-Cool-Auto; duel fuel.
<b>T8600C</b>	<b>One-stage heat and one-stage cool thermostat; system powered; system switch—HEAT-OFF-COOL; fan switch—ON-AUTO</b>		
T8600C1014	TRADELINE® thermostat; Honeywell logo; conventional.	T8600D2028	Separate O & B terminals; duel fuel.
T8600C1030	Canadian TRADELINE® thermostat; Honeywell logo; conventional; degree C; O and B terminals.	T8600D2028	Configure for °C in Installer Setup 14; duel fuel; jumper R to Rc.
T8600C1048	York logo; conventional; part no. 2ET07700124A.	T8600D2028	Separate O & B terminals; duel fuel.
T8600C1055	Canadian TRADELINE® thermostat; Honeywell logo; conventional; degree C.	T8600D2028	Configure for °C in Installer Setup 14; duel fuel; jumper R to Rc.
T8600C1063	Trane logo; conventional; part no. THT0594.	T8600D2028	Separate O & B terminals; duel fuel.
T8600C1071	Trane logo; electric heat; O and B terminals; part no. THT0595.	T8600D2028	Configure for electric heat in Installer Setup 2; jumper R to Rc.
T8600C1089	Texfan logo; conventional.	T8600D2028	Separate O & B terminals; duel fuel.
T8600C1097	Glowcore logo; conventional; part no. THC-3.	T8600D2028	Separate O & B terminals; duel fuel.
T8600C1105	York logo; conventional; part no. 025-27653 and 2ET0770224A.	T8600D2028	Separate O & B terminals.
T8600C1113	Canadian York thermostat; conventional; degree C.	T8600D2028	Separate O & B terminals; configure for °C in Installer Setup 14; duel fuel.
T8600C1121	Arcoaire logo; conventional; part no. 1506-745.	T8600D2028	Separate O & B terminals; duel fuel.
T8600C1147	Trane logo; conventional; part no. TAYSTAT300.	T8600D2028	Separate O & B terminals; duel fuel; jumper R to Rc.
T8600C1154	American Standard logo; conventional; part no. ASYSTAT600.	T8600D2028	Separate O & B terminals; duel fuel; jumper R to Rc.
T8600C1162	SUPER TRADELINE® thermostat; Honeywell logo; duel fuel fan control; O and B terminals.	T8600D2028	Jumper R to Rc.

(continued)

**Table 14. Thermostat Cross Reference Information. (continued)**

<b>Model Number</b>	<b>Description</b>	<b>TRADELINE® Replacement</b>	<b>Remarks</b>
T8600C1170	Carrier thermostat; conventional; part no. HH07AX006.	T8600D2028	Separate O & B terminals; duel fuel; jumper R to Rc.
T8600C1188	Carrier thermostat; conventional; part no. HH641-101.	T8600D2028	Separate O & B terminals; duel fuel; jumper R to Rc.
T8600C1196	Canadian TRADELINE® thermostat; Honeywell logo; Premier White® color; conventional; degree C.	T8600D2028	Separate O & B terminals; configure for °C in Installer Setup 14; duel fuel; jumper R to Rc.
T8600C1204	Canadian Lennox thermostat; conventional; degree C.	T8600D2028	Separate O & B terminals; configure for °C in Installer Setup 14; duel fuel; jumper R to Rc.
T8600C1212	SUPER TRADELINE® thermostat; Honeywell logo; duel fuel fan control; O and B terminals.	T8600D2028	Jumper R to Rc; taupe color.
T8600C1220	Servel logo; Premier White® color; conventional; Robur part no. 15471-82.	T8600D2028	Separate O & B terminals; duel fuel; taupe color.
T8600C1238	ICP logo; Premier White® color; duel fuel fan control; O and B terminals; part no. HQ1149371HW.	T8600D2028	Jumper R to Rc; taupe color.
T8600C1246	ICP logo; Premier White® color; duel fuel fan control; O and B terminals; part no. HQ1149372HW.	T8600D2028	Jumper R to Rc; taupe color.
T8600C1253	Consolidated Industries logo; Premier White® color; conventional; part no. 412360.	T8600D2028	Separate O & B terminals; duel fuel; taupe color.
T8600C1279	Canadian TRADELINE® (French) thermostat; conventional.	T8600D2028	English only keyboard; separate O & B terminals; duel fuel.
<b>T8600D</b>	<b>One-stage heat and one-stage cool conventional thermostat; system powered; automatic changeover; system switch— HEAT-OFF-COOL-AUTO; fan switch— ON-AUTO</b>		
T8600D1004	TRADELINE® thermostat; Honeywell logo.	T8600D2028	Separate O & B terminals; duel fuel.
T8600D1012	Canadian TRADELINE® thermostat; Honeywell logo; degree C.	T8600D2028	Separate O & B terminals; configure for °C in Installer Setup 14; duel fuel.
T8600D1020	Energy Sensor.	T8600D2028	Separate O & B terminals; duel fuel.
T8600D1038	Canadian Carrier thermostat; degree C; part no. HH07AT101.	T8600D2028	Separate O & B terminals; configure for °C in Installer Setup 14; duel fuel;
T8600D1046	Trane.	T8600D2028	Separate O & B terminals; duel fuel.
T8600D1053	Heil Quaker thermostat; Honeywell logo; part no. HQ1000776HW.	T8600D2028	Separate O & B terminals; duel fuel.
T8600D1061	Carrier.	T8600D2028	Separate O & B terminals; duel fuel.
T8600D1079	Lennox logo; part no. 27H3101.	T8600D2028	Separate O & B terminals; duel fuel.
T8600D1103	Carrier.	T8600D2028	Separate O & B terminals; duel fuel.
T8600D1111	TRADELINE® thermostat; Honeywell logo; Premier White® color.	T8600D2028	Separate O & B terminals; duel fuel; taupe color.
T8600D1129	Canadian TRADELINE® thermostat; Honeywell logo; Premier White® color; degree C.	T8600D2028	Separate O & B terminals; configure for °C in Installer Setup 14; duel fuel.
T8600D1137	Solitaire logo; Premier White® color; Nordyne part no. 9132400.	T8600D2028	Separate O & B terminals; duel fuel; taupe color.
T8600D1145	Canadian Carrier thermostat; Premier White® color; degree C; part no. HH07AT101-W.	T8600D2028	Separate O & B terminals; configure for °C in Installer Setup 14; duel fuel.

(continued)

**Table 14. Thermostat Cross Reference Information. (continued)**

<b>Model Number</b>	<b>Description</b>	<b>TRADELINE® Replacement</b>	<b>Remarks</b>
<b>T8601A</b>	<b>One-stage conventional heat thermostat; powered direct from 24 Vac transformer</b>		
T8601A1017	Canadian TRADELINE® thermostat; Honeywell logo; system switch—none; fan switch—none; degree C.	T8601D2019	Heat/cool model can be used for heat only; system selection Heat-Off-Cool-Auto; configure for °C in Installer Setup 14; Premier White® color.
<b>T8601B</b>	<b>One-stage conventional heat with fan thermostat; powered direct from 24 Vac transformer</b>		
T8601B1007	TRADELINE® thermostat; Honeywell logo; system switch—none; fan switch—ON-AUTO .	T8601D2019	Heat/cool model can be used for heat only; system selection Heat-Off-Cool-Auto; jumper R to Rc for fan control; Premier White® color.
<b>T8601C</b>	<b>One-stage heat and one-stage cool conventional thermostat; powered direct from 24 Vac transformer; system switch—HEAT-OFF-COOL; fan switch—ON-AUTO; O and B terminals</b>		
T8601C1003	TRADELINE® thermostat; Honeywell logo.	T8601D2019	Jumper R to Rc; Premier White® color.
T8601C1013	Canadian TRADELINE® thermostat; Honeywell logo; degree C.	T8601D2019	Configure for °C in Installer Setup 14; jumper R to Rc; Premier White® color.
T8601C1021	New Construction thermostat.	T8601D2019	Jumper R to Rc; Premier White® color.
T8601C1039	Carrier logo; part no. HH641-104.	T8601D2019	Jumper R to Rc; Premier White® color.
T8601C1047	New Construction thermostat; Premier White® color.	T8601D2019	Jumper R to Rc.
T8601C1054	Trol-A-Temp® thermostat; Premier White® color.	T8601D2027 <sup>a</sup>	Configure manual changeover in Installer Setup12; replacement has Oc terminals.
T8601C1062	Trol-A-Temp® by Honeywell logo.	T8601D2027 <sup>a</sup>	Configure manual changeover in Installer Setup12; replacement has Oc terminals; Premier White® color.
<b>T8601D</b>	<b>One-stage heat and one-stage cool conventional thermostat; powered direct from 24 Vac transformer; automatic changeover; system switch—HEAT-OFF-COOL-AUTO; fan switch—ON-AUTO</b>		
T8601D1011	Canadian TRADELINE® thermostat; Honeywell logo; degree C.	T8601D2019	Separate O & B terminals; configure for °C in Installer Setup 14 and changeover in 12; jumper R to Rc; Premier White® color.
T8601D1029	New Construction thermostat.	T8601D2019	Separate O & B terminals; configure changeover in Installer Setup 12; jumper R to Rc; Premier White® color.
T8601D1045	Trol-A-Temp® by Honeywell thermostat; Premier White® color.	T8601D2027 <sup>a</sup>	Separate O & B terminals; replacement has Oc terminals.
T8601D1052	New Construction thermostat; Premier White® color.	T8601D2019	Separate O & B terminals; configure changeover in Installer Setup 12; jumper R to Rc.
T8601D1060	California Economizer logo; Premier White® color.	T8601D2019	Separate O & B terminals; configure changeover in Installer Setup 12; jumper R to Rc.
T8601D1078	Amana logo; Premier White® color; part no. P1213701F.	T8601D2019	Separate O & B terminals; configure changeover in Installer Setup 12; jumper R to Rc.

(continued)

**Table 14. Thermostat Cross Reference Information. (continued)**

<b>Model Number</b>	<b>Description</b>	<b>TRADELINE® Replacement</b>	<b>Remarks</b>
<b>T8602A</b>	<b>One-stage heat conventional thermostat; battery powered; system switch—none; fan switch—none</b>		
T8602A1008	TRADELINE® thermostat; Honeywell logo.	T8602D2000	Heat/cool model can be used for heat only; separate O & B terminals; system selection Heat-Off-Cool-Auto; fan selection Auto-On.
<b>T8602B</b>	<b>One-stage heat conventional with fan thermostat; battery powered; system switch—none; fan switch—ON-AUTO</b>		
T8602B1006	TRADELINE® thermostat; Honeywell logo.	T8602D2000	Heat/cool model can be used for heat only; separate O & B terminals; system selection Heat-Off-Cool-Auto; fan selection Auto-On; jumper R to Rc for fan operation.
T8602B1014	TRADELINE® thermostat; Honeywell logo; Premier White® color.	T8602D2000	Heat/cool model can be used for heat only; separate O & B terminals; system selection Heat-Off-Cool-Auto; fan selection Auto-On; jumper R to Rc for fan operation; taupe color.
<b>T8602C</b>	<b>One-stage heat and one-stage cool thermostat; battery powered; system switch—HEAT-OFF-COOL; fan switch—ON-AUTO</b>		
T8602C1004	TRADELINE® thermostat; Honeywell logo.	T8602D2000	Separate O & B terminals; jumper R to Rc.
T8602C1012	Amana logo; conventional; part no.: none.	T8602D2000	Separate O & B terminals; jumper R to Rc.
T8602C1020	Rheem logo; conventional; part no.: none.	T8602D2000	Separate O & B terminals; jumper R to Rc.
T8602C1046	SUPER TRADELINE® thermostat; Honeywell logo; duel fuel fan control; O and B terminals.	T8602D2000	
T8602C1061	Trol-A-Temp® by Honeywell thermostat; Premier White® color; conventional; O and B terminals.	T8602C2051 <sup>a</sup>	
T8602C1079	Trol-A-Temp® by Honeywell thermostat; conventional; O and B terminals.	T8602C2051 <sup>a</sup>	Premier White® color.
T8602C1095	SUPER TRADELINE® thermostat; Honeywell logo; Premier White® color; duel fuel fan control; O and B terminals.	T8602D2000	Taupe color.
T8602C1103	Canadian TRADELINE® thermostat; Honeywell logo; duel fuel fan control; degree C; O and B terminals.	T8602D2000	Configure for °C in Installer Setup 14 .
T8602C1129	Universal Parts logo; Rheem part no. 41-21615-05; conventional.	T8602D2000	
T8602C1137	ICP logo; duel fuel fan control; O and B terminals; part no. HQ1149373HW.	T8602D2000	
T8602C1145	ICP logo; Premier White® color; duel fuel fan control; O and B terminals; part no. HQ1149374HW.	T8602D2000	Taupe color.

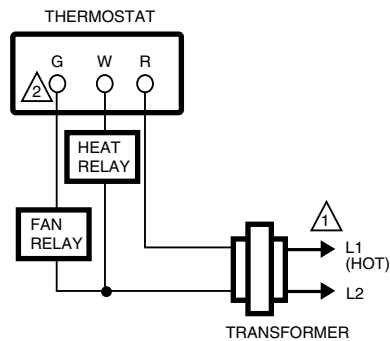
(continued)

Table 14. Thermostat Cross Reference Information. (continued)

Model Number	Description	TRADELINE® Replacement	Remarks
<b>T8602D</b>	<b>One-stage heat and one-stage cool conventional thermostat; battery powered; automatic changeover</b>		
T8602D1010	Trol-A-Temp® by Honeywell thermostat; Premier White® color; system switch—none; fan switch—none; field terminals: W/4, R/5, Y/6.	T8602D2026 <sup>a</sup>	
T8602D1028	Trol-A-Temp® by Honeywell thermostat; system switch—none; fan switch—none; field terminals: W/4, R/5, Y/6.	T8602D2026 <sup>a</sup>	Premier White® color.
<b>CT8602C</b>	<b>One-stage heat and one-stage cool retail thermostat battery powered</b>		
CT8602C1001	Retail Honeywell logo; off-white color; duel fuel fan control; system switch HEAT-OFF-COOL; fan switch ON-AUTO; separate O and B terminals; clamshell packaging.	T8602D2000	TRADELINE® packaging.

<sup>a</sup> Trol-A-Temp® by Honeywell thermostat model.

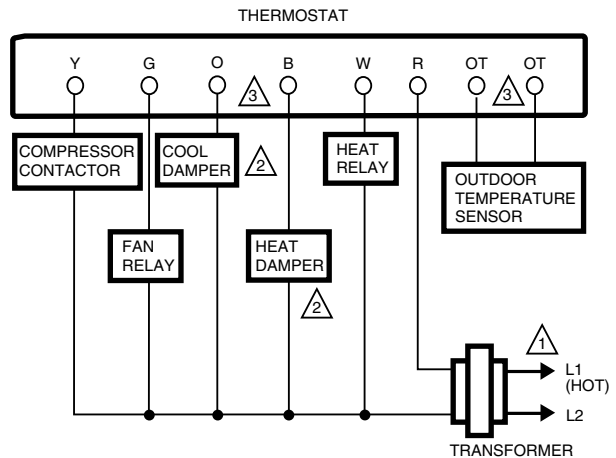
## WIRING DIAGRAMS (Fig. 15-20)



1 POWER SUPPLY. PROVIDE DISCONNECT MEANS AND OVERLOAD PROTECTION AS REQUIRED.

2 NOT AVAILABLE ON T8600A MODELS. M10346

Fig. 15. Typical hookup of T8600 or T8602 in heat only application.



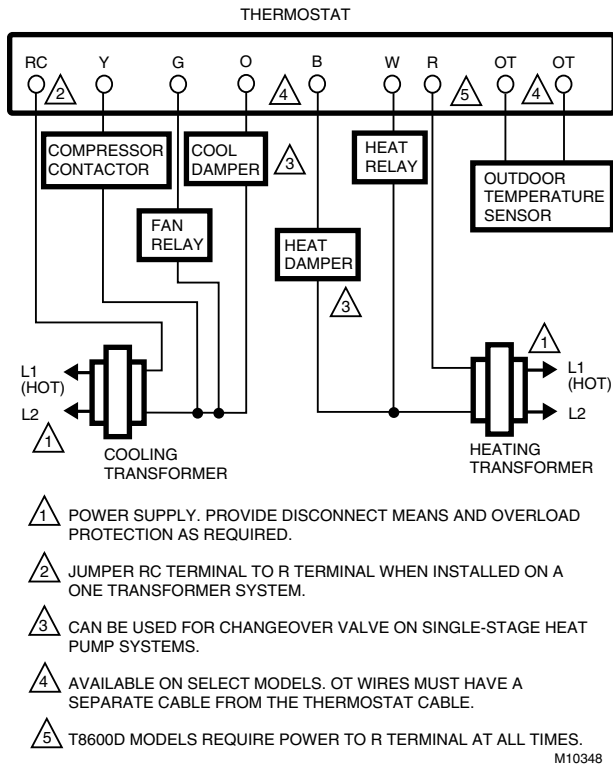
1 POWER SUPPLY. PROVIDE DISCONNECT MEANS AND OVERLOAD PROTECTION AS REQUIRED.

2 CAN BE USED FOR CHANGEOVER VALVE ON SINGLE-STAGE HEAT PUMP SYSTEMS.

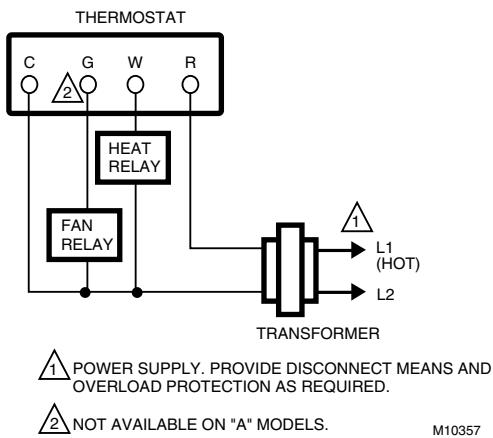
3 AVAILABLE ON SELECT MODELS. OT WIRES MUST HAVE A SEPARATE CABLE FROM THE THERMOSTAT CABLE. M10347

Fig. 16. Typical hookup of T8600 or T8602 in heat and cool system with one transformer.

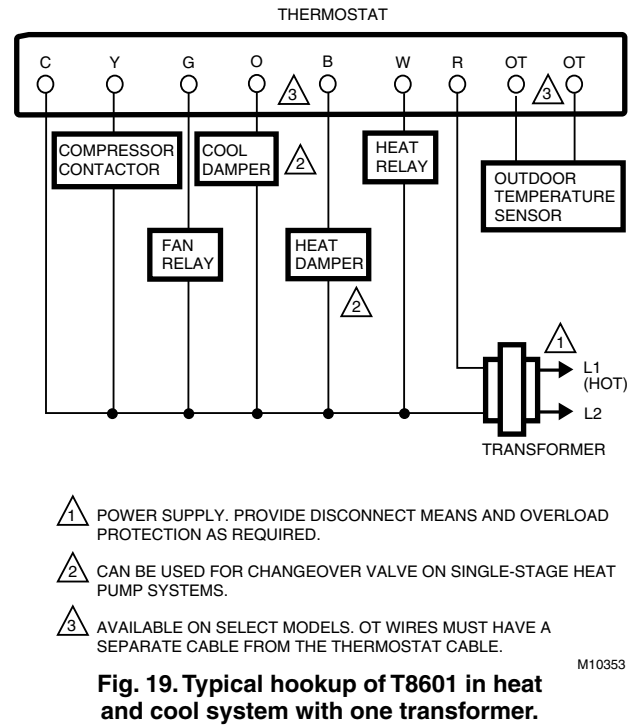




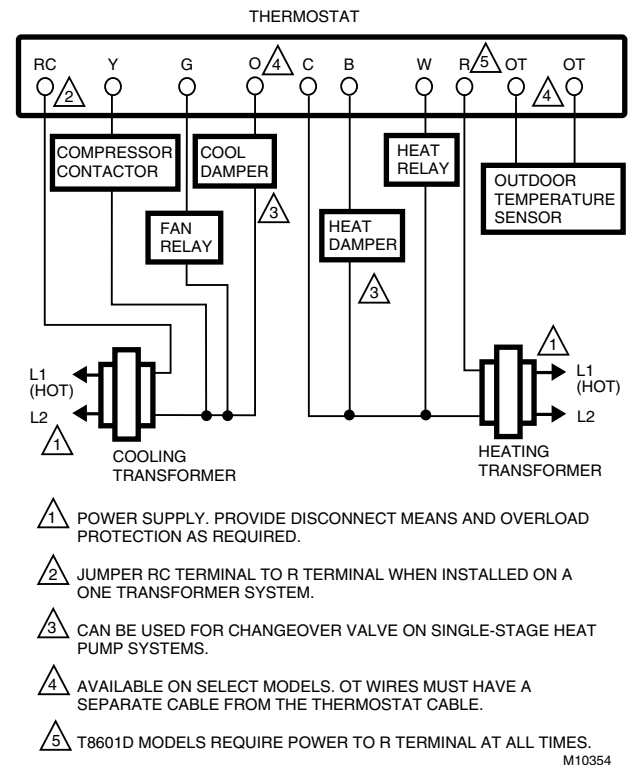
**Fig. 17. Typical hookup of T8600 or T8602 in heat and cool system with two transformers.**



**Fig. 18. Typical hookup of T8601 in heat only application.**



**Fig. 19. Typical hookup of T8601 in heat and cool system with one transformer.**



**Fig. 20. Typical hookup of T8601 in heat and cool system with two transformers.**





**Home and Building Control**

Honeywell Inc.  
Honeywell Plaza  
P.O. Box 524  
Minneapolis MN 55408-0524

**Honeywell Latin American Region**

480 Sawgrass Corporate Parkway  
Suite 200  
Sunrise FL 33325

**Home and Building Control**

Honeywell Limited-Honeywell Limitée  
155 Gordon Baker Road  
North York, Ontario  
M2H 3N7

**Honeywell Europe S.A.**

3 Avenue du Bourget  
B-1140 Brussels Belgium

**Honeywell Asia Pacific Inc.**

Room 3213-3225  
Sun Hung Kai Centre  
No. 30 Harbour Road  
Wanchai  
Hong Kong

---

**Honeywell**

